

HDI

Bench Scale

INDUSTRIAL WEIGHING SOLUTION™

HDI

Bench Scale



LAB-OBORUDOVANIE.RU

CAS

CAS BLDG., #1315, YANGJAE-DAERO,
GANGDONG-GU, SEOUL, KOREA
TEL_ 82 2 2225 3500
FAX_ 82 2 475 4668

CAS

www.globalcas.com

OWNER'S MANUAL

CONTENTS

PRECAUTIONS	4
PREFACE.....	6
NAMES AND FUNCTIONS.....	6
INSTALLATION & CONNECTION	7
CALIBRATION	8
OPERATIONS.....	10
1. General Weighing	11
2. Weighing with Tare.....	11
3. Counting Mode	12
4. Weight Comparison Function(HI/OK/LOW) ..	13
5. Print Out	15
6. Battery Charge.....	16
7. Set-up Mode.....	16
8. User Mode	17
ERROR MESSAGES.....	18
SERIAL INTERFACE	18
SPECIFICATIONS.....	19
HOW TO INSTALL HDI Series.....	20
ASSEMBLING THE DISPLAY OF HDI	
WALL TYPE	21

PRECAUTIONS

Warning

Precautions when installing the scale. To ensure that you get the most from your scale, please follow these instructions.

Do not disassemble the scale.

When any damage or defect occurs, contact your CAS authorized dealer immediately for proper repair.



Do not overload beyond the maximum weight limit.



Scale must be grounded to minimize electricity static.

This will minimize defect or electric shock.



Do not pull the plug by its cord when unplugging.

Damaged cord could cause electric shock or fire.



To prevent from fire occurring. Do not place or use the scale near flammable or corrosive gas.



To reduce electric shock or incorrect reading. Do not spill water on the scale or place it in humid condition.



Avoid placing the scale near heater or in direct sunlight.



Insert plug firmly to wall outlet to prevent electric shock.



Use proper Adapter.

Incorrect adapter could damage the scale.

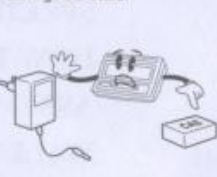

Do not step up on the scale with wet feet. Platter becomes slippery. Humid condition may cause incorrect reading.



Attention

Make sure to plug your scale into the proper power outlet. For maximum performance, plug into a power outlet 30 minutes before the usage for warm up.

For consistent and accurate reading, maintain periodical check by your CAS authorized dealer.

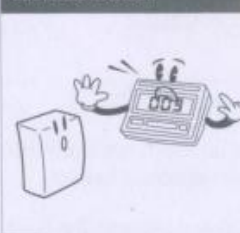

Avoid sudden shock to the scale.



Grab on the bottom of the scale when moving.



Keep the scale away from other electromagnetic generating devices.

This may interfere with accurate reading.



Place the scale on firm and temperature consistent environment.



Take the battery out when scale is not in use for long time. Leakage from the batteries is hazardous.



PREFACE

Thank you for the purchasing of CAS HDI Series.

This series have been designed with CAS reliability, under rigid quality control and with outstanding performance. Your specialty departments can enjoy with CAS products.

We hope that CAS product meets your needs.

The user manual is designed to guide you to understand product operation and proper care of product.

NAMES AND FUNCTIONS

OVERALL VIEW

■ HDI

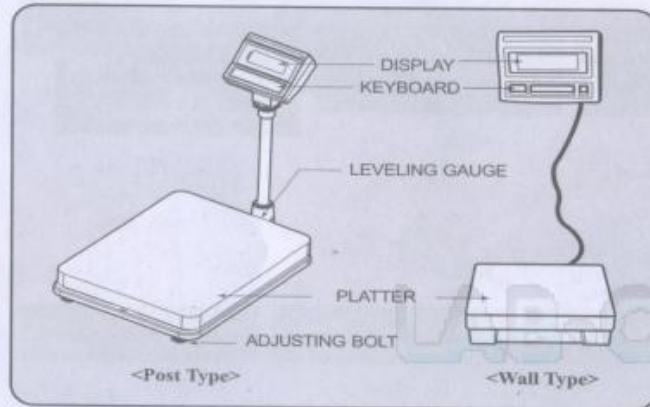

INSTALLATION & CONNECTION

Load cell connection

Connect load cell connector to load cell port which is in the backside of the indicator.

* Connecting method

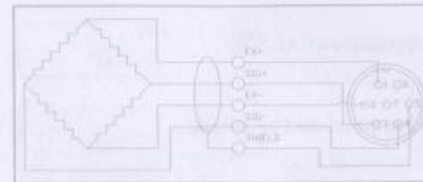

IN	COLOR
1 (EXC+)	RED
2 (EXC-)	WHITE
3 (SIG+)	GREEN
4 (SIG-)	BLUE
5 (SHIELD)	SHIELD

Note. Wire color can be different depending on the loadcell's manufacturer or it's model.

* Load cell output to Resolution

5V impression to loadcell Max. load cell output	Recommended resolution
4 mV	1/4,000
8 mV	1/8,000
10 mV	1/10,000

CALIBRATION

- Product initialization



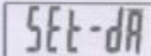

Press  key to go to Power on

 When numbers on the display appears press CAL S/W.



 There will be a beeping sound as the product initializes.

- General Calibration

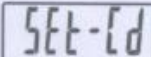

* If the product initiation process is skipped, the #4 value will automatically be set to the previously set value and the setup process will be skipped.

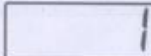
1. Pressing and holding calibration switch press  key to go to calibration mode.
2. Pressing and holding   key press  key to go to calibration mode.

3. 

  key: Quick value settings. "1/2/5/10/20/50/DUAL"

 Select

4.   key: Set-point digits
"00000/0000.0/000.00/00.0000/0.00000/0.00000"

 Select

5.    key: Full Capa. Setting (Input values are converted to grams)

*When the quick value setting is Dual "3060 : 30-60kg , 6015: 60-150kg , 1530: 150-300kg"

 Select



Calibration mode

Zero Calibration (Check that the scale reads zero) 

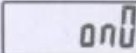



 

Span Calibration Input value. Note: Input values in Kg.

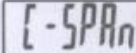

Place the previously inputted amount of weight on the scale and then

press  Select

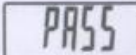

Calibration complete

LAB-OBORUDOVANIE.RU

OPERATIONS DISPLAY AND KEYBOARD

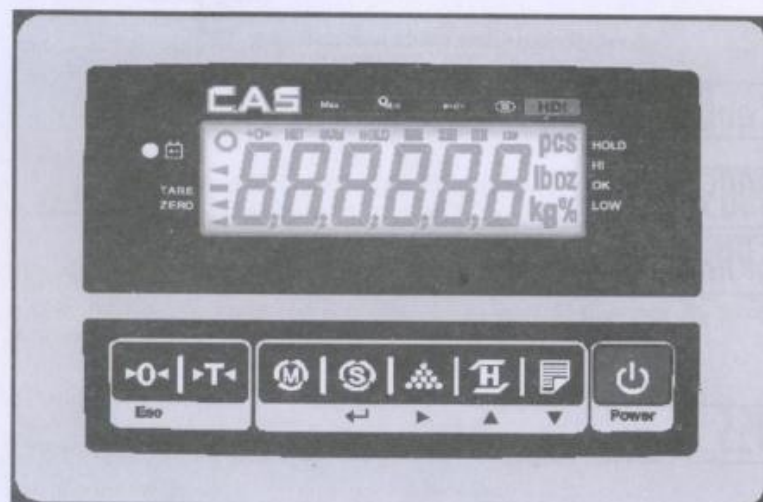

KEY FUNCTIONS

KEYS	DESCRIPTIONS
	Used to set the zero point to 0.00. Used as an ESC key in Setup Mode.
	Used to enter a tare weight and used to cancel a tare weight.
	Used to convert the mode as below. [kg] → [pcs] → [%] → [WEIGHT LIMIT ON/OFF] → [COUNT LIMIT ON/OFF] → [kg]
	Used as an ENTER key.
	Used to calculate a unit weight of a sample. [▶] Used to enter next digit.
	Used to display average weight. [▲] Used to have number up.
	PRINT key. [▼] Used to have number down.
	Used to turn ON or OFF the power.

1. General Weighing

■ The display indicates if the scale is at zero or if there is a tare entered into the scale by way of a ZERO and NET.

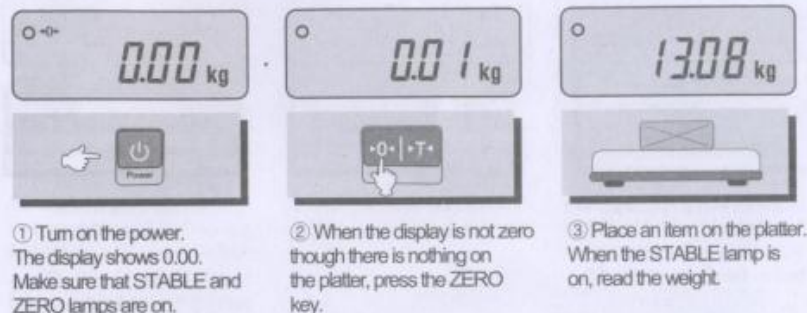

① Turn on the power.
The display shows 0.00.
Make sure that STABLE and
ZERO lamps are on.

② When the display is not zero
though there is nothing on
the platter, press the ZERO
key.

③ Place an item on the platter.
When the STABLE lamp is
on, read the weight.

2. Weighing with Tare

■ Tare is the weight of container being used for a commodity.
The TARE key subtracts the weight of the container.

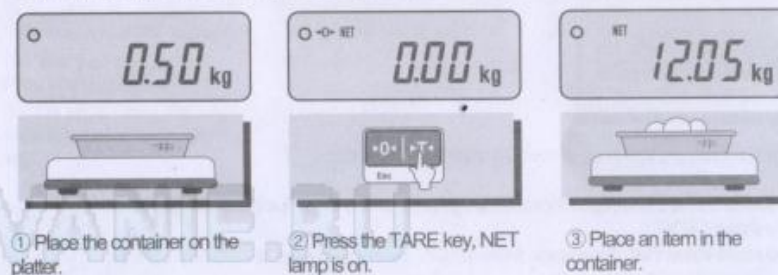

① Place the container on the
platter.

② Press the TARE key, NET
lamp is on.

③ Place an item in the
container.



④ To release the TARE function, remove an item and
container from the platter and press the TARE key.

3. Counting Mode

■ Samples on the platter.



① Press the MODE key until the display shows "WL OFF". If you have set sample size before the display shows "0".

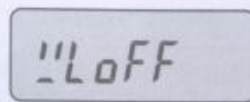

② Press the SAMPLE key, then the display shows "10".

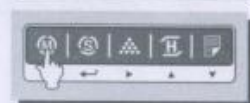
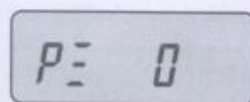

③ If you want to increase sample size, press the SAMPLE key. The display shows 10, 20, 50, 100, 200 every time pressing the SAMPLE key.



④ If you set sample size to 10, place 10 samples on the platter.

⑤ Press the SET key. The display shows unit weight and then shows the number of samples. If the display shows "LACK"

• The small value that can escape from "LACK" message is over MAX CAPA / 3000.

- a. unit weight $\leq 0.8 e^*$
- b. weight load $\leq 2\%$ of maximum weighing capacity.

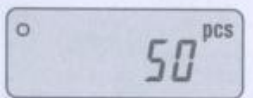

⑥ Place parts on the platter, then the display shows the number of parts. You can also use tare function in counting mode.

4. Weight Comparison Function(HI/OK/LOW)

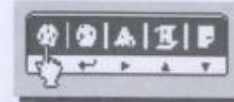
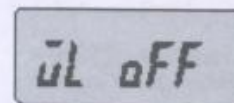

① Press the MODE key until the display shows "WL OFF". It means that weight limit function is deactivated.

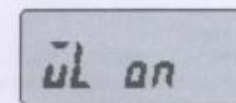

② Press the SAMPLE key to activate this function, the display shows "WL ON".

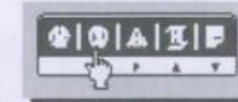
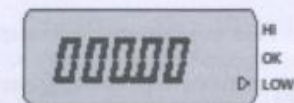

③ Press the SET key to set up low value, the display shows "000.00".

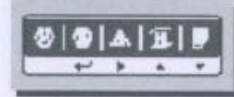

④ Press the HOLD(\blacktriangle) or PRINT(\blacktriangledown) key to have number up or down. To enter next digit, press the SAMPLE key.



⑤ Press the SET key to set up high value, the display shows "H000.00".

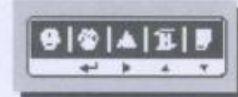

⑥ Press the HOLD(\blacktriangle) key to have number up or down. To enter next digit, press the SAMPLE (\blacktriangleright) key.

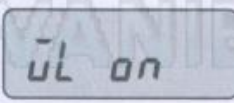

⑦ Press the SET key, the display shows "End".

⑧ If you set up LOW/HIGH limit wrong, "WL ERR" will be shown on the display. Then you have to set it up again. For example) LOW=100.00kg HIGH=90.00kg → High limit is lower than Low limit.

⑨ Press the MODE key to go to weighing mode.

⑩ Suppose that the High limit of 70kg and the Low limit of 30kg are set up. In this condition, **OK** lamp is lighted on if the weight is 40kg, **HI** lamp is lighted on if the weight is 80kg and if the weight is 20kg,

LO lamp is lighted on. It beeps as fixed on User Setup Mode.



5. Print Out

5-1. Manual Print

■ You can print out data every time pressing the PRINT key. You can setup print function depends on your need. Refer to User Mode Table on page 17.

5-2. Auto Print

① To use auto print function, you have to set printer method = 1 in User mode. Refer to User Mode Table on page 17.

② If the weight is stable, it is printed out automatically.
And You can print out data every time pressing the PRINT key.

5-3. Stream Print

① To use auto print function, you have to set printer method = 2 in User mode. Refer to User Mode Table on page 17.

② If the weight is stable, it is printed out continuously

< Print Format >



12.000 Kg

15.000 Kg







6. Battery Charge

- Warning message is shown when the battery voltage is very low. ()
 - At this time, charge the battery.
 - The display will show a red lamp and the battery will begin a fast charge automatically.
- Use only the ac adapter which comes with the scale. Other AC adapter may cause damage.

7. SET-UP MODE

Pressing and holding   key press  key to go to set-up mode.

000005



     
(a) (b) (c) (d) (e) (f)

- (a) Zero Tracking 0~9d
- (b) Minimum Tracking Digit 0~9d
- (c) Measure of weight after zero tracking 0~9d
- (d) Initial Zero Range 0=20% 1=100%
- (e) Vibration Filter 0=high 1=middle 2=low
- (f) 0=Colon 1=Semicolon







Default: 123100

Zero Tracking : 1d
Minimum Tracking Digit : 2d
Measure of weight after zero tracking : 3d
Initial Zero Range : 1 = 100%, Vibration Filter : 0 = high, 0 = Colon

8. User Mode

Pressing and holding  key press  key to go to user mode.

000005

     
(a) (b) (c) (d) (e) (f)

- (a) Backlight: 1-Auto, 2-On, 3-Off
- (b) Auto Power Off: 0-off, 1-10min, 2-30min, 3-60min
- (c) Unit of measure: 0-Kg, 1-lb
- (d) Baud Rate : 0=4800 1=9600 2=19200
- (e) Print method : 0=Auto print when the scale is stable
1=Print continually when the scale is stable
2=Manual print
- (f) Not Use

Default : 100120

Backlight : 1-Auto
Auto Power Off : 0-Off
Unit of measure : 0-Kg
Baud Rate : 1-9600bps
Print method : 2-Manual print

ERROR MESSAGES

Error Message on Display	Description	Solution
"Err 0"	The "Err 0" occurs when scale is not stable.	Remove unstable facts.
"Err 1"	The "Err 1" occurs when a current zero point has shifted from the last span calibration.	Please call your CAS dealer.
"Err 3"	The "Err 3" is an overload error.	Please remove the weight.
"Err 9"	The "Err 9" is no weight error. When scale is in counting mode, you must load the weight. If you have no weight on your scale, you can see this error message.	Please load the weight on your tray.
"Err 14"	The "Err 14" means calibration range is not correct.	Please call your CAS dealer.

SERIAL INTERFACE

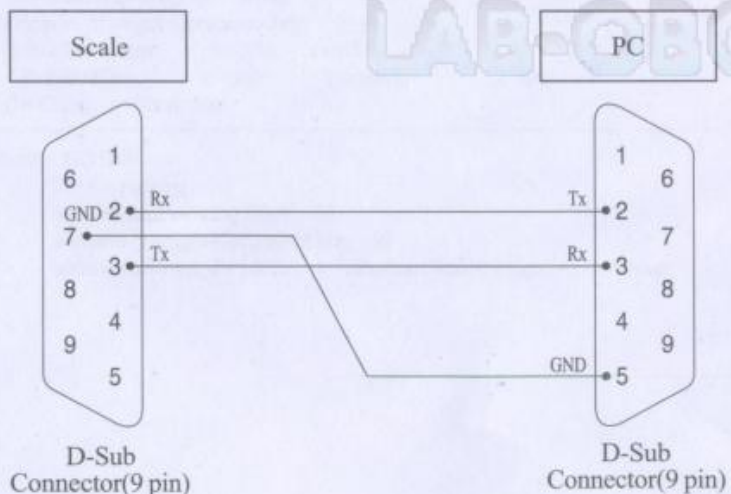

SPECIFICATIONS

Load Cell Excitation Voltage	DC 5 V
Zero Adjustment Range	0.05 mV ~ 5 mV
Input Sensitivity	2 uV/D
A/D Internal Resolution	1/300000
A/D External Resolution	1/30000
Division	X1, x2, x5, x10, x20, x50
A/D Conversion Speed	10 Hz
Display Below Zero	Minus
DISPLAY	LCD 6 digits 110mm(W) X 35mm(H)
DISPLAY LAMP	STABLE, ZERO, HOLD, NET, HI/OK/LO, lb, PCS, kg, Low Battery
INTERFACE	RS-232C(Printer)
POWER SOURCE	DC 12 V 1.25 A Adaptor 6 V 4 Ah Pb Battery
TEMPERATURE RANGE	-10 °C ~ +40 °C
PRODUCT SIZE (WDH)mm	220(W)X159(D)X107(H)
PRODUCT WEIGHT	1.5 kg
MINIMUM VOLTAGE LEVEL OF THE BATTERY	About 5.6 V
CONTINUOUS USING TIME	About 100 Hours(Back light Off) About 25 Hours(Back Light On) *The load Cell Specification can have an effect on using time.
RECHARGING	About 12 Hours

► Notice: Specifications are subject to change for improvement without notice.

HOW TO INSTALL HDI Series

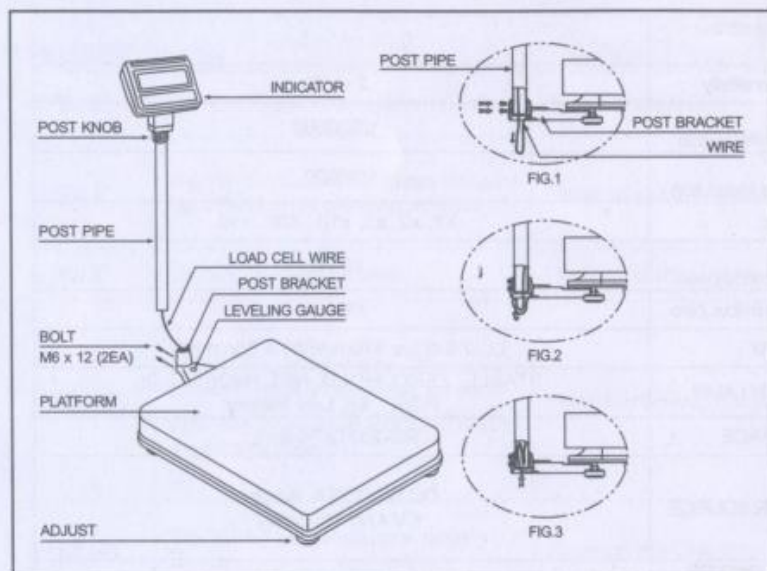

1. Open the box with care because indicator is connected to the scale with load cell wire.
2. Turn the post knob so as to fix indicator.
3. Pull down the wire out of post pipe and insert the post pipe to the post bracket. (Refer to fig. 1)
4. Fasten the post pipe with two bolts. (Refer to fig. 1)
A long bolt should be connected to the upper side.
5. Insert the wire to the post pipe. (Refer to fig. 2, 3)
6. If the scale is not properly level, please adjust 4 leg (adjusting bolt) at the bottom of the scale so as to center the bubble of the leveling gauge.

※ Note : Place the scale on a flat and stable surface.
Inside the indicated circle.

ASSEMBLING THE DISPLAY OF HDI WALL TYPE

1. Attach head bracket to the display and fasten it with screws provided as shown in Figure. 1.
2. Connect both of ground wire and load cell wire to load cell connector at the backside of display as shown in Figure. 2.
3. Fasten ground wire to the bottom of platform body with bolt as shown in Figure. 3.

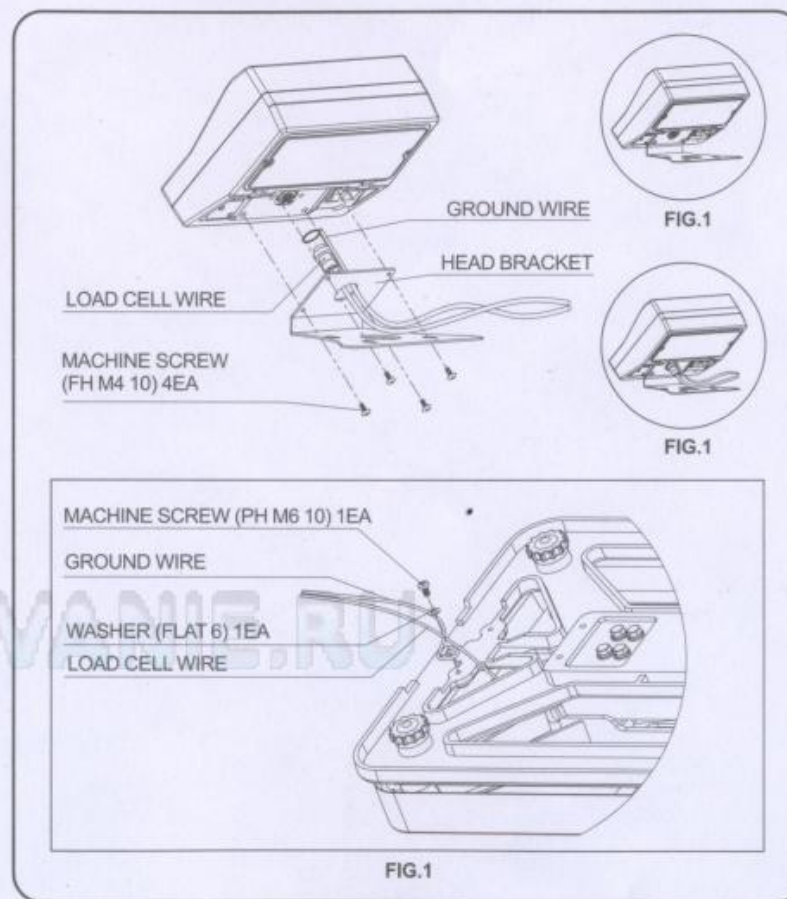

FIG.1